



* Shown with optional peripherals

Touchmonitor User Guide

1529L 15" LCD Desktop Touchmonitor, 3000 series
(Optional Magnetic Stripe Reader, Barcode Scanner,
Customer Display and Biometric available)



Our commitment. Your advantage.

Elo TouchSystems

15" LCD Touchmonitor

**Optional Magnetic Stripe Reader,
Customer Display, Barcode Scanner**

User Guide

Revision G

P/N 008603E

Elo TouchSystems
1-800-EL TOUCH
www.elotouch.com

Copyright © 2009 Tyco Electronics. All Rights Reserved.

No part of this publication may be reproduced, transmitted, transcribed, stored in a retrieval system, or translated into any language or computer language, in any form or by any means, including, but not limited to, electronic, magnetic, optical, chemical, manual, or otherwise without prior written permission of Tyco Electronics.

Disclaimer

The information in this document is subject to change without notice. Tyco Electronics makes no representations or warranties with respect to the contents hereof, and specifically disclaims any implied warranties of merchantability or fitness for a particular purpose. Tyco Electronics reserves the right to revise this publication and to make changes from time to time in the content hereof without obligation of Tyco Electronics to notify any person of such revisions or changes.

Trademark Acknowledgments

AccuTouch, CarrollTouch, Elo TouchSystems, IntelliTouch, Tyco Electronics and TE (logo) are trademarks of the Tyco Electronics group of companies and its licensors. Windows is a trademark of the Microsoft group of companies. Other product names mentioned herein may be trademarks or registered trademarks of their respective companies. Tyco Electronics claims no interest in trademarks other than its own.

Table of Contents

Chapter 1		
Introduction	1	
Product Description	1	
Detailed LCD Display Performance Requirements	2	
Customer Display	3	
Serial Version	3	
Fingerprint Reader	3	
Theory of Operation	4	
Sensor Specifications	4	
Credit Card Reader	4	
Barcode Scanner	4	
Omni-directional scanner	4	
1-D scanner	5	
Six Port USB Hub	5	
External 12 VDC Power Supply	5	
Chapter 2		
Installation and Setup	6	
Unpacking Your Touchmonitor.	6	
Product Overview	7	
Main Unit	7	
Rear View	7	
Side View	8	
Base Bottom View	8	
Kensington™ Lock	9	
USB Interference Connection	10	
Remove the cable cover	10	
USB/Serial Interference Connection	16	
Remove the cable cover	16	
Replace the cable cover	22	
Optimizing the LCD Display	23	
Installing the Peripheral Device Drivers	23	
Finger Print Reader	23	
Magnetic Stripe Reader	24	
Testing the USB MSR Keyboard Emulation	24	
Testing the USB-HID Class MSR	24	
Convert MSR from HID to Keyboard emulation ...	24	
Convert MSR from Keyboard emulation to HID ..	25	
Rear Facing Customer Display	25	
Barcode Scanner	26	
Installing the Driver Software	28	
Installing the Serial Touch Driver (not applicable to Acoustic Pulse Recognition monitor)	29	
Chapter 3		
Operation	30	
About Touchmonitor Adjustments	30	
15" LCD Function Key	31	
Controls and Adjustment	32	
OSDLock/Unlock	32	
Power Lock/Unlock	32	
OSD Menu Functions	32	
OSD Control Options	33	
Brightness	33	
Contrast	33	
Sharpness	33	
Phase	33	
Auto Adjust	33	
OSD Left/Right	33	
OSD Up/Down	33	
Clock	33	
Color Temperature	33	
Current Input	33	
OSD Position	33	
Language	33	
Recall Defaults	33	
OSD Timeout	33	
Input Video Select	33	
Volume	33	
Power-Save (No Input)	34	
Power LED Display & Power Saving	34	
General Power Saving Mode	34	
Display Angle	34	
Controls and Adjustment	36	
OSDLock/Unlock	36	
Power Lock/Unlock	36	
OSD Menu Functions	36	
OSD Control Options	37	
Brightness	37	
Contrast	37	
Sharpness	37	
Phase	37	
Auto Adjust	37	
OSD Left/Right	37	
OSD Up/Down	37	
Clock	37	
Color Temperature	37	
Current Input	37	
OSD Position	37	
Language	37	
Recall Defaults	38	
OSD Timeout	38	
Input Video Select	38	
Volume	38	
Chapter 4		
Troubleshooting	39	
Solutions to Common Problems	39	
Appendix A		
Touchmonitor Safety	40	
Care and Handling of Your Touchmonitor	41	
Appendix B		
Technical Specifications	42	
Touchmonitor Specifications	43	
15" LCD Touchmonitor (1529L) Dimension	44	
15" LCD Touchmonitor (1529L) Dimension	44	
Regulatory Information	45	
Warranty	48	

INTRODUCTION

Product Description

The 1529L is a retail terminal designed to present information to the operator and the customer. The 1529L is available in serial and USB versions or combo touch monitor. The 1529L consists of a 15.0" LCD main display with a touchscreen and the following optional peripherals: customer display, vacuum fluorescent display (VFD) Customer Display, fingerprint reader, barcode scanner, credit card reader, and a 6 port USB (USB version only) Hub. The main display element is a 15.0 inch diagonal XGA resolution (1024 x 768) LCD display. The main display will consist of an LCD Display and touchscreen. Four types of touchscreens can be selected in the 1529L as options. They are AccuTouch, Intellitouch, and carrollTouch and Acoustic Pulse Recognition.

The fingerprint reader translates illuminated images of fingerprints into digital code for further software processing, e.g. enrollment (fingerprint registration) and verification (authentication of registered users). The fingerprint reader uses the SEIR method and CMOS image sensor to capture high contrast, high resolution fingerprint images. A series of algorithms extracts minutiae data from the image, mapping the distinguishing characteristics of fingerprint ridge ends, splits, dots, and arches. To identify or verify a fingerprint, a proprietary matching algorithm compares the extracted minutiae points from the input fingerprint on the optical module to a previously stored sample. The entire matching process takes roughly one second. There is a fingerprint reader available in the USB version of the 1529L.

The credit card reader reads all three stripes on a standard credit card or drivers license. The credit card is read by sliding the credit card, stripe side toward the display through the credit card reader forward or backward. There is a USB credit card reader only.

The Hub provides 4 internal USB ports to be used by the credit card reader, the fingerprint reader or barcode scanner, the touchscreen, and the customer display. The hub also supplies two USB ports to the outside of the back of the 1529L for external use. The hub is only used by the USB version of the 1529L. The 1529L is powered by a universal AC power source or 12 VDC from external power source.

The barcode scanner comes in two different configurations. The first is a high-end omni-directional scanner, which is also capable of reading 2-D barcodes. And the second is a lower cost, yet efficient, 1-D scanner. Both scanners run on a USB interface.

Detailed LCD Display Performance Requirements

15 inch TFT LCD Display Panel

Display Format	1024 x 768
Display area 15"	304.1mm(H) x 228mm(V)
Pixel Pitch 15"	0.297mm(H) x 0.297mm(V)
Contrast Ratio	500:1 typical
Brightness	
LCD	350 cd/m ² (Typical) ; 270 cd/m ² (Minimum)
AccuTouch	280 cd/m ² (Typical) ; 203 cd/m ² (Minimum)
IntelliTouch	315 cd/m ² (Typical) ; 230 cd/m ² (Minimum)
CarrollTouch	315 cd/m ² (Typical) ; 230 cd/m ² (Minimum)
Surface Capacitive	298 cd/m ² (Typical) ; 216 cd/m ² (Minimum)
Acoustic Pulse Recognition	315 cd/m ² (Typical) ; 230 cd/m ² (Minimum)
Accutouch Transmission	80% typical ; 75% minimum
IntelliTouch Transmission	90% typical ; 85% minimum
IR Touchscreen Transmission	90% typical ; 85% minimum
Surface Capacitive Transmission	85% typical ; 80% minimum
Acoustic Pulse Recognition	90% typical ; 85% minimum
Response Time	Tr+Tf=8msec typical
Display Color	16.2 million colors, 6 Bit + FRC
Vertical Viewing Angle	Typical Vertical Viewing Angle: 60deg(looking down)/60 deg(lookingup) @ CR>=10
Horizontal Viewing Angle	Typical Vertical Viewing Angle: 70deg(looking down)/70 deg(lookingup) @ CR>=10

Customer Display

The Customer Display is a twenty character two line vacuum fluorescent display (VFD). It consists of a VFD and VFD controller.

Serial Version

Optional Parameters

Characters per row	20
Number of rows	2
Character configuration	5x7 dot matrix
Character Height	9.5mm
Character width	6.2mm
Character configuration	ASCII
Character color	Blue green
MTBF	300,000 hours

Fingerprint Reader

There is a fingerprint reader in the USB version only.

General Description-FDU01B is a PC peripheral FRD (Fingerprint Recognition Device) for USB (Universal Serial Bus) connections.

Specifications

Sensor	SecuGen FOR
Image Capture Speed	600ms/frame
Image Transfer Speed	500Byte/ms
Pixel Resolution	356x292
USB Signaling Type	Full Speed Type

Theory of Operation

The USB host initiates communication with the FDU01 using operation commands (Sensor LED On, Fingerprint Capture Start and Stop). Fingerprint data are then captured by the CMOS sensor at a total image size of 356 x 292 with 8-bit gray level. The image frame transfer speed is 500 bytes/ms. It takes about 600 milliseconds to send one frame of image data over USB protocols. FDU01 uses the SecuGen FOR (Fingerprint Optic Reader).

Sensor Specifications

Sensor	CMOS Image Sensor
Resolution	500dpi
Verifying Time	<1sec
Image Capture Error Rate	<0.1%
Life Time Typically	40,000Hrs

Credit Card Reader

There is a USB credit card reader only. The USB version is available in HID and Keyboard emulation versions. The reader reads all three stripes on a standard credit card or drivers license.

Reference Standards-Conform to applicable standards	International Standards Organization, American National Standards Institute, California Drivers License, American Association of Motor Vehicle Administrators
Message Format	ACCII
Card Speed	3 to 50 IPS
MTBF Electronics	125,000 hrs; Head 1,000,000 passes

Barcode Scanner

Omni-directional scanner:

1. Ability to read 1D codes with a 360° rotation, eliminating the need to orient the scanner in the field of view
2. Scan angle
Minimum horizontal: $34^{\circ} \pm 1.5^{\circ}$
Minimum vertical: $12.5^{\circ} \pm 1.5^{\circ}$
3. Ability to read 2-D barcodes (PDF417, Micro PDF)
4. Ability to read damaged or poorly printed barcodes

5. Effective form factor; ability to be mounted on side of ET1529L
6. USB interface that complies with USB 2.0 standards
7. USB bus powered
8. Easy communication between host and scanner
9. Visible laser diode operating at 650nm
- 10.600+ scans/sec

1-D scanner:

1. Ability to read 1-D codes
2. Scan angle
Minimum: $47^{\circ} \pm 3^{\circ}$
3. Low cost solution
4. Effective form factor; ability to be mounted on side of ET1529L
5. USB interface that complies with USB 2.0 standards
6. USB bus powered
7. Easy communication between host and scanner
8. Visible laser diode operating at 650nm
9. 100+ scans/sec

Six Port USB Hub

The Hub provides 4 internal USB ports to be used by the credit card reader, the fingerprint reader, the touchscreen, and the customer display. The hub also supplies two USB ports to the outside of the back of the 1529L for external use. The hub is only used by the USB version of the 1529L. The hub meets the following requirements:

Specification

Full compliance with USB specification 1.0, 1.1 and HID Class Definition Rev 1.0.

Hub shall be self powered

Hub shall provide 2 external and 4 internal downstream ports with individual port over current detection, protection and recovery. Supports both Open Host Controller Interface (OHCI) and Universal Host Controller Interface (UHCI).

Supports Suspend and Resume operation.

Bus fault detection and recovery.

External Power Supply

The 1529L shall be powered by a universal AC power source or 12 VDC from external power source. The power supply shall provide the following capability:

AC power: Input voltage 85 to 265 vac

Input frequency 47 to 63hz

DC power: Input voltage 12 vdc

Input line and load regulation +/-2%

INSTALLATION AND SETUP

This chapter discusses how to install your LCD touchmonitor and how to install Elo TouchSystems driver software.

Unpacking Your Touchmonitor

Check that the following items are present and in good condition:



Touchmonitor

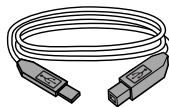

USB Cable

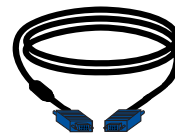

Video cable

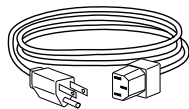

Power cable US/Canadian

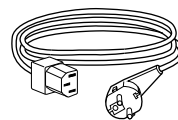

European power cable

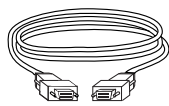

DVI cable

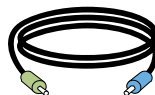

Speaker

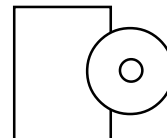

CD and Quick Install Guide

Product Overview

Main Unit



Note: Shown with optional Biometric & MSR.

Rear View



Note: Shown with optional Rear Facing Customer Display.

Side View



Base Bottom View



or



Kensington™ Lock

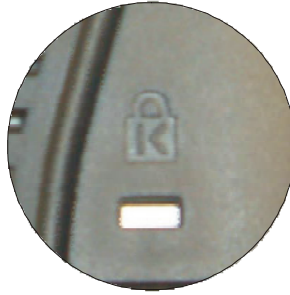

The Kensington™ lock is a security device that prevents theft. To find out more about this security device, do to <http://www.kensington.com>.

USB Interface Connection

Your touchmonitor comes with only one touchscreen connector cables: **USB** cable. (For Windows 2000, Me and XP systems only.)

To set up the display, please refer to the following figures and procedures:

Remove the Cable Cover

The cables are connected at the back of the monitor.



cable cover

To remove the cover, grasp the lip of the cover and pull towards you until it snaps off.

CAUTION

Before connecting the cables to your touchmonitor and PC, be sure that the computer and touchmonitor are turned off.

**NOTE**

Before connecting the cables to the touchmonitor, route all the cables through the hole in the second as shown in the picture above.

The following illustrations guide you step by step in connecting your touchmonitor using a USB cable connection.

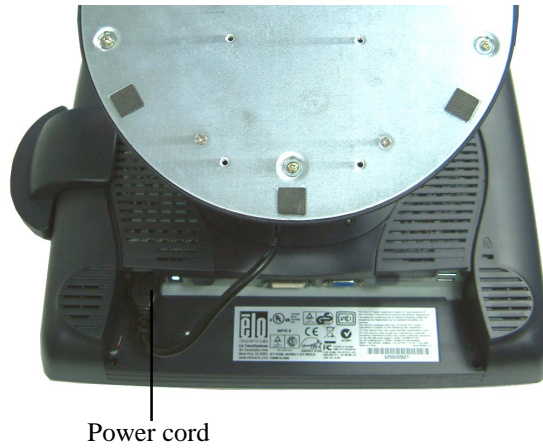

Connect one end of the **power cord** to the monitor and the other end to wall.
Connect the power cable to the power port in the monitor.



Video cable

Connect one end of the **video cable** to the rear side of computer and the other to the LCD. Tighten by turning the two thumb screws clockwise to ensure proper grounding. You can select DVI video cable or D-SUB15 video cable.



DVI cable

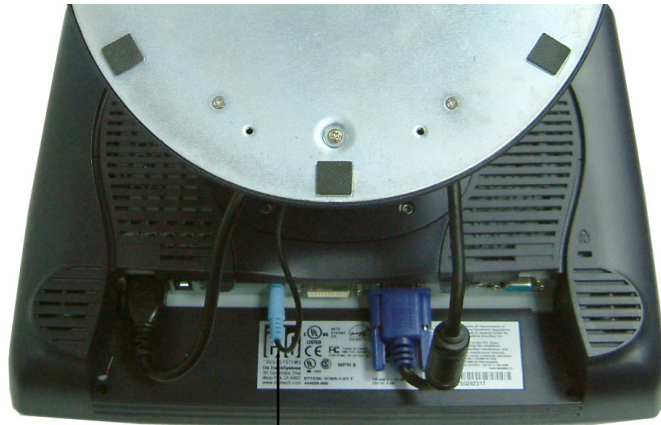

Speaker cable

Connect one end of the **speaker cable** to the speaker port in the computer and the other end to the port in the monitor.



USB cable

Connect one end of the **USB cable** to the rear side of the computer and the other to the LCD monitor.

The USB cable is for optional touch, MSR, CD and Finger Print Reader. Only one USB cable is needed because the device contains a self powered USB 1.1 Hub. Two self powered ports are available for running other USB devices. For touch only, no USB Hub is present.

USB / SERIAL Interface Connection

Your touchmonitor comes with only one touchscreen connector cables: **USB** cable. (For Windows 2000, Me and XP systems only.)

To set up the display, please refer to the following figures and procedures:

Remove the Cable Cover

The cables are connected at the back of the monitor.



cable cover

To remove the cover, grasp the lip of the cover and pull towards you until it snaps off.

CAUTION

Before connecting the cables to your touchmonitor and PC, be sure that the computer and touchmonitor are turned off.

**NOTE**

Before connecting the cables to the touchmonitor, route all the cables through the hole in the second as shown in the picture above.

The following illustrations guide you step by step in connecting your touchmonitor using a USB cable connection.



Power cord

Connect one end of the **power cord** to the monitor and the other end to wall.
Connect the power cable to the power port in the monitor.



Video cable

Connect one end of the **video cable** to the rear side of computer and the other to the LCD. Tighten by turning the two thumb screws clockwise to ensure proper grounding. You can select DVI video cable or D-SUB15 video cable.



DVI cable

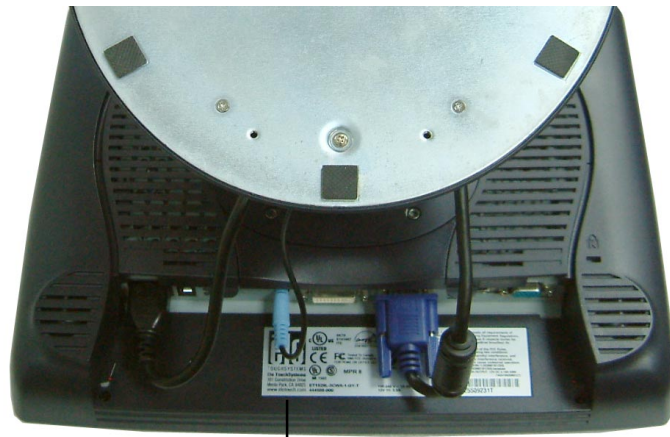

Speaker cable

Connect one end of the **speaker cable** to the speaker port in the computer and the other end to the port in the monitor.



USB cable

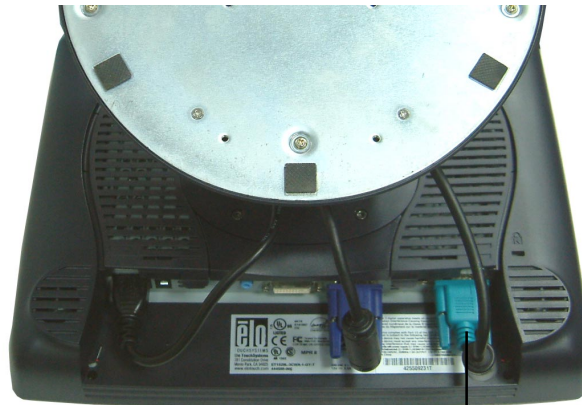

Serial cable

For USB interface, connect one end of the USB cable to the rear side of the computer and the other to the LCD monitor.

For Serial interface, connect one end of the RS-232 cable to the rear side of the computer and the other to the LCD monitor.

Replace the Cable Cover

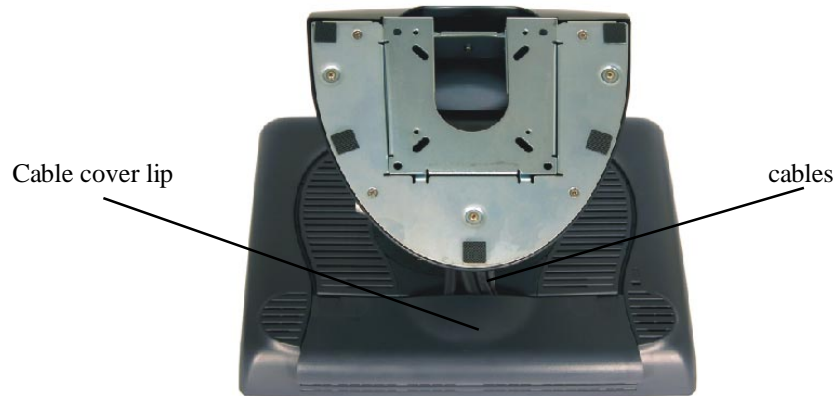

Then you have attached all the cables to the monitor, gently bring all the cables toward the standard so they fit under the cover lip.

Snap the Cable cover in place over the connections.

Optimizing the LCD Display

To ensure the LCD display works well with your computer, configure the display mode of your graphic card to make it less than or equal to 1024 x 768 resolution, and make sure the timing of the display mode is compatible with the LCD display. Refer to Appendix A for more information about resolution. Compatible video modes for your touchmonitor are listed in Appendix C.

Installing the Peripheral Device Drivers

Finger Print Reader

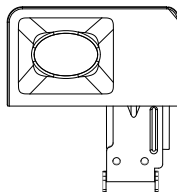

NOTE: This driver is for MS Windows 9x through XP.

1 On the TouchTools CD, browse to **Touch Monitor Peripherals\Finger Print Readers\Fingerprint Reader 229L 1529L\Driver Install\Drivers**.

2 Double-click *setup.exe*

Follow the Install Shield Wizard procedure to complete the installation.

For a detailed software development kit, browse to **Touch Monitor Peripherals\Finger Print Readers\Fingerprint Reader 229L 1529L\Driver Install\Drivers** and open the following files:

- FDxSDKforWindows1 .20.zip
- SecuBSPSDK for Windows2 .10.zip

You will enter one of the following serial numbers depending on your operating system:

- FDx SDK for Windows: 31-100s101-3586383
- FDx SDK for Windows CE: 32-100s101-9713291
- SecuBSP SDK for Windows: 41-100s101-7685871
- SecuBSP SDK for Windows CE: 42-100s101-1155462
- SecuBSP SDK: 51-100s101-5963137

Once the driver setup is complete, the demo program can be run from **Touch Monitor Peripherals\Finger Print Readers\Fingerprint Reader 229L 1529L\Demo\BSPDemo.exe**

Magnetic Stripe Reader

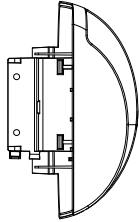

No device are needed.

Testing the USB MSR Keyboard Emulation

- 1 Plug in the device.
- 2 Open MS Word.
- 3 Slide the card through the MSR to view the data.

Testing the USB-HID Class MSR

- 1 On the CD, browse to **Touch Monitor Peripherals\Magnetic Stripe Card Readers\Demo**.
- 2 Open the **Readme.txt** and follow instructions to test the unit.

Convert MSR from HID to keyboard Emulation

- 1 To convert from HID mode to Keyboard Emulation mode
 - 1.1 Double-click on the “MSR Change Mode” icon on the desktop.
The following will appear:

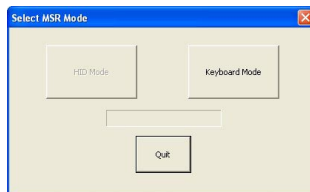

- 1.2 The dim box will indicate the current setting. Click the “Keyboard Mode” to switch to Keyboard Emulation mode.
 - 1.3 Click “Quit” to close the window.
- 2 Open Notepad.
- 3 Slide the card through the MSR to view the data.

Convert MSR from keyboard emulation to HID

1 To convert from Keyboard Emulation mode to HID mode

1.1 Double-click on the “MSR Change Mode” icon on the desktop.

The following will appear:

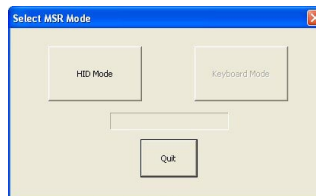

1.2 The dim box will indicate the current setting. Click the “HID Mode” to switch to HID mode.

1.3 Click “Quit” to close the window.

Rear Facing Customer Display



1. Insert your Elo TouchTools CD.
2. On the CD, browse to ***Touch Monitor Peripherals\Rear Facing Customer Display\Drivers\USB Drivers***. Click on the folder that has the name of your operating system for the necessary drivers.
3. Once in this folder, open up the zip file and open the install text file for further driver installation instructions.

* Note: If your software requires **OPOS Drivers**, it is available in the following location:
Touch Monitor Peripherals\Rear Facing Customer Display\Drivers\OPOS Drivers.

Test Applications:

1. Insert your Elo TouchTools CD.
2. On the CD, browse to ***Touch Monitor Peripherals\Rear Facing Customer Display\Testing\USB***.
3. Open up the text file named ***USB Test*** and follow the instructions. This testing procedure assumes you have already installed the necessary USB drivers.

Barcode Scanner

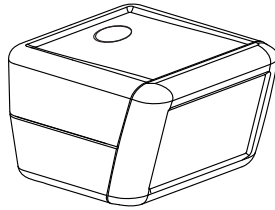

1. Insert your Elo TouchTools CD.
2. On the CD, browse to *Touch Monitor Peripherals\Barcode Scanner Startup\Drivers*.
3. Double-click on *USB7210.msi* and follow the prompts given by the setup file.
4. Once you have finished installing the above: Right click on *My Computer* and click on *Properties*. Click on the *Hardware* tab and then click *Device Manager*.
5. Double click on *USB7210 Converter Module*, which should be located in the *Other Devices* section. Next click on *Reinstall Driver*.
6. Now your Windows operating system should guide you through the rest of the installation process. If any files are requested, please provide the following pathname in your Elo TouchTools CD: *Touch Monitor Peripherals\Barcode Scanner Startup\Drivers*.

Test Applications:

1. Insert your Elo TouchTools CD.
2. On the CD, browse to *Touch Monitor Peripherals\Barcode Scanner Startup\Test Applications*.
3. Double click on *Scanner Test Application Readme*. This document will explain how to test your scanner for basic functionality.

Your scanner default settings do not enable 2-D barcode reading ability. In order to enable this option, follow these steps:

- 1) Scan the barcodes below to enable PDF417 and MicroPDF417. These are both types of 2-D barcodes.

2) Now scan the barcode below to change your scanning pattern. Using this scanning pattern will allow you to read 2-D barcodes (you can still read 1-D barcodes also).



**Always Raster
(02h)**

The scanner module also adds a Hall Effect Switch (HE Switch) that enables the unit to automatically set the Trigger mode of the Scan Engine depending on the location of an external magnet (included in scanner cradle).

The output of the HE Switch switches low (turns ON) when a magnetic field (south polarity) perpendicular to the Hall sensor exceeds the operate point threshold, B_{OP} (typically 100 G magnetic field). When the magnetic field is reduced below the release point, B_{RP} , (typically 45 G magnetic field) the HE Switch output goes high (turns OFF). The Hall Effect Switch goes to the USB Controller's DSR input. As the HE Switch opens or closes, it causes the USB Controller to initiate a USB Interrupt message to the host. When the Host Application software detects the DSR input active LOW via the USB Interrupt and a CDC message (HE Switch is ON), it sends a 'Continuous Trigger' SSI command to the Symbol Scan Engine.

The Scan Engine turns on the laser and is able to scan and decode barcodes continuously without the user having to press the trigger (momentary switch). When the Host Application software detects the DSR input HIGH (HE Switch is OFF), it sends a 'Level Trigger' SSI command to the Symbol Scan Engine. The Scan Engine turns off the laser and will scan and decode barcodes only when the trigger is activated.

Installing the Driver Software

Elo TouchSystems provides driver software that allows your touchmonitor to work with your computer. Drivers are located on the enclosed CD-ROM for the following operating systems:

- Windows 7
- Windows Vista
- Windows XP
- Windows 2000
- Windows Me
- Windows 98
- Windows 95
- Windows NT 4.0
- Windows 3.1
- MS-DOS

Additional drivers and driver information for other operating systems are available on the Elo TouchSystems web site at www.elotouch.com.

The Elo touchmonitor is plug-and-play compliant. Information on the video capabilities of your touchmonitor is sent to your video display adapter when Windows starts. If Windows detects your touchmonitor, follow the instructions on the screen to install a generic plug-and-play monitor.

Refer to the following appropriate section for driver installation instructions.

Depending upon whether you connected the serial communication cable or the USB communication cable, only the serial driver or the USB driver should be installed.

Installing the Serial Touch Driver (not applicable to Acoustic Pulse Recognition monitor)

Installing the Serial Touch Driver for Windows 7, Windows Vista, Windows XP, Windows 2000, ME, 95/98 and NT4.0.

NOTE: For Windows 2000 and NT4.0 you must have administrator access rights to install the driver. Make sure the serial connector (RS232) is plugged into the monitor and an open com port on the PC.

- 1 Insert the Elo CD-ROM in your computer's CD-ROM drive.
- 2 If the AutoStart feature for your CD-ROM drive is active, the system automatically detects the CD and starts the setup program.
- 3 Follow the directions on the screen to complete the driver setup for your version of Windows.
- 4 If the AutoStart feature is not active:
- 5 Click **Start > Run**.
- 6 Click the **Browse** button to locate the EloCd.exe program on the CD-ROM.
- 7 Click **Open**, then **OK** to run EloCd.exe.
- 8 Follow the directions on the screen to complete the driver setup for your version of Windows.

OPERATION

About Touchmonitor Adjustments

Your touchmonitor will not likely require adjustment. Variations in video output and application may require adjustments to your touchmonitor to optimize the quality of the display.

For best performance, your touchmonitor should be operating in native resolution, that is 1280 x 1024 at 80k-75 Hz. Use the Display control panel in Windows to choose 1280 x 1024 resolution.

Operating in other resolutions will degrade video performance. For further information, Please refer to Appendix A.

All adjustments made to the controls are automatically memorized. This features saves you from having to reset the choices every time the touchmonitor is unplugged or powered off and on. If there is a power fail here, the touchmonitor settings will not default to the factory specifications.

15" LCD Function Key

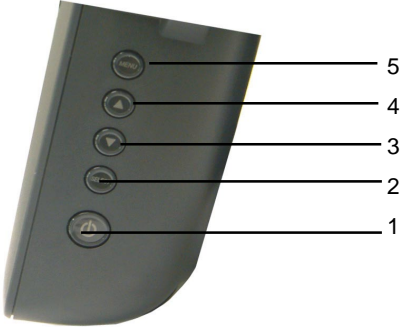

	Controls	Function
1	Power Switch	Turns the display system power on or off .
2	Select	Displays the OSD menus on the screen and used to select (“Clockwise” and “Counter-clockwise” direction) the OSD control options on the screen.
3	▼	Adjusts the decreasing value of the selected OSD control option.
4	▲	Adjusts the increasing value of the selected OSD control option.
5	Menu	Menu display and menu exit.

Controls and Adjustment

OSD Lock/Unlock

You are able to lock and unlock the OSD feature. The monitor is shipped in the unlocked position.

To lock the OSD:

- 1 Press the Menu button and ▲ button simultaneously for 2 seconds. A window will appear displaying “OSD Unlock”. Continue to hold the buttons down for another 2 seconds and the window toggles to “OSD Lock”.

Power Lock/Unlock

You are able to lock/unlock the Power feature. The monitor is shipped in the unlocked position. To lock the power:

- 1 Press the Menu button and the ▼ simultaneously for 2 seconds. A window for another 2 seconds and the window toggles to —Power Lock“.

OSD Menu Functions

To display the OSD Menu press the **Menu** button.

- 1 Press the ▲ button or ▼ button to select the different OSD control option.
- 2 When the function you want to change is displayed, press the **Select** button.

To adjust the Value of the function:

- 1 Pressing the ▲ button increases the value of the selected OSD control option.
- 2 Pressing the ▼ button decreases the value of the selected OSD control option.

After adjusting the values, the monitor will automatically save the changes.

NOTE: The OSD screen will disappear if no input activities are detected for 45 seconds.

OSD Control Options

Brightness

- Background Luminance of the LCD panel is adjusted.

Contrast

- Adjusts the contrast or the values of color gain (RED, GREEN or BLUE).

Sharpness

- The sharpness can be adjustable.

Phase

- Adjusts the phase of the dot clock.

Auto Adjust

- Clock system auto adjustment (under 5 seconds).

OSD Left/Right

- The OSD screen is moved vertically right and left.

OSD Up/Down

- The OSD screen is moved vertically up and down.

Clock

- Adjusts the ratio of dividing frequency of the dot clock.

Color Temperature

- Sets R, G, B gain.

Current Input

- The frequency of the horizontal/vertical synchronizing signal under the input indicated. (This information is under Auto Adjust icon)

OSD Position

- Allows the OSD indication position to be selected.

Language

- Select the language used for the OSD menu from among English, France, Deutsch, Spanish and Japanese.

Recall Defaults

- All data copy from factory shipment data.

OSD Timeout

- Adjust time for OSD to disappear.

Input Video Select

- Select D-SUB Analog, DVI Digital signal.

Volume

- To increase or decrease the sound level.

Power-Save (No Input)

- The LCD panel background is cut when there is no signal input (AC line power consumption of 4w or less).

Power LED Display & Power Saving

General Power Saving Mode

When the power switch are switch **on**, this LED lights in **green**.

The LED indicates the different power status with altered LED colors when monitor operates in different modes (see following table).

Mode	Power Consumption	Indicator
On	50w max.	Green
Sleep	4w max.	Orange
Off	2w	NO

We recommend switching the monitor off when it is not in use for a long period of time.

Display Angle

For viewing clarity, you can tilt the LCD forward up 67 to 90 degrees.

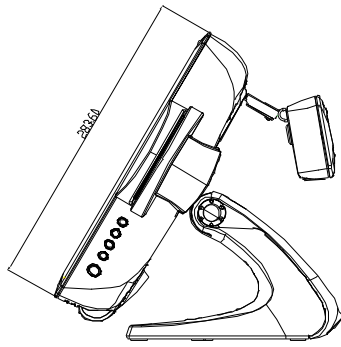

Tilt 30° from vertical

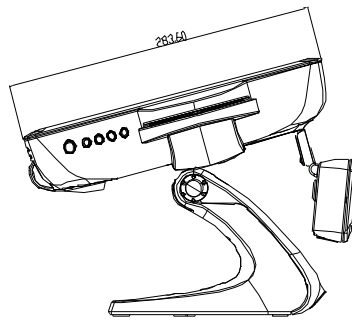

Tilt 75° from vertical

CAUTION

In order to protect the LCD, be sure to hold the base when adjusting the LCD, and take care not to touch the screen.

Controls and Adjustment

OSD Lock/Unlock

You are able to lock and unlock the OSD feature. The monitor is shipped in the unlocked position.

To lock the OSD:

- 1 Press the Menu button and ▲ button simultaneously for 2 seconds. A window will appear displaying “OSD Unlock”. Continue to hold the buttons down for another 2 seconds and the window toggles to “OSD Lock”.

Power Lock/Unlock

You are able to lock/unlock the Power feature. The monitor is shipped in the unlocked position. To lock the power:

- 1 Press the Menu button and the ▼ simultaneously for 2 seconds. A window for another 2 seconds and the window toggles to —Power Lock“.

OSD Menu Functions

To display the OSD Menu press the **Menu** button.

- 1 Press the ▲ button or ▼ button to select the different OSD control option.
- 2 When the function you want to change is displayed, press the **Select** button.

To adjust the Value of the function:

- 1 Pressing the ▲ button increases the value of the selected OSD control option.
- 2 Pressing the ▼ button decreases the value of the selected OSD control option.

After adjusting the values, the monitor will automatically save the changes.

NOTE: The OSD screen will disappear if no input activities are detected for 45 seconds.

OSD Control Options

Brightness

- Background Luminance of the LCD panel is adjusted

Contrast

- Gain of R, G, and B signal is adjusted.

Sharpness

- The sharpness can be adjustable.

Phase

- The phase of the dot clock is adjusted.

Auto Adjust

- Automatically adjusts the systems dot clock(takes approximately 5 seconds).

OSD Left/Right

- The osd screen is moved horizontally left and right.

OSD Up/Down

- The OSD screen is moved vertically up and down.

Clock

- The ratio of dividing frequency of the dot clock is adjusted.

Color Temperature

- Sets the R, G, and B gains.

Current Input

- The frequency of the horizontal/vertical synchronizing signal under the input is indicated.(These information is under auto Adjust icon)

OSD Position

- The osd indication position can be selected.

Language

- Select the language for the OSD menu from among English, France, Deutsch, Spanish and Japanese.

Recall Defaults

- Restore all original factory defaults.

OSD Timeout

- Adjust how long the OSD menu is displayed.

Input Video Select

- Select D-SUB Analog, dvi Digital signal.

Volume

- To increase or decrease the sound level.

4

TROUBLESHOOTING

If you are experiencing trouble with your touchmonitor, refer to the following table. If the problem persists, please contact your local dealer or our service center.

Solutions to Common Problems

Problem	Suggestion(s)
The monitor does not respond when turning on the system.	<ol style="list-style-type: none">1. Check that the monitor's Power Switch is on.2. Turn off the power and check the monitor's DC power cord and signal cable for proper connection.
Characters on the screen are dim	Refer to the About Touchmonitor Adjustments section to adjust the brightness.
The video is blank	<ol style="list-style-type: none">1. During operation, the monitor screen may automatically turn off as a result of the Power Saving feature. Press any key to see if the screen reappears.2. Refer to the About Touchmonitor Adjustments section to adjust the brightness.
Screen flashes when initialized	Turn the monitor off then turn it on again.
"Out of Range" display	Reconfigure the resolution of your computer to make one of the monitor's supported video mode (see Appendix C). See Appendix A for more information on resolution.
Touch doesn't work	Make sure the touch cable is securely attached at both ends.



TOUCHMONITOR SAFETY

This manual contains information that is important for the proper setup and maintenance of your touchmonitor. Before setting up and powering on your new touchmonitor, read through this manual, especially Chapter 2 (Installation), and Chapter 3 (Operation).

- 1 To reduce the risk of electric shock, follow all safety notices and never open the touchmonitor case.
- 2 Turn off the product before cleaning.
- 3 The slots located on the sides and top of the touchmonitor case are for ventilation. Do not block or insert anything inside the ventilation slots.
- 4 It is important that your touchmonitor remains dry. Do not pour liquid into or onto your touchmonitor. If your touchmonitor becomes wet do not attempt to repair it yourself.

Care and Handling of Your Touchmonitor

The following tips will help keep your touchmonitor functioning at the optimal level.

- To avoid risk of electric shock, do not disassemble the brick power supply or display unit cabinet. The unit is not user serviceable. Remember to unplug the display unit from the power outlet before cleaning.
- Do not use alcohol (methyl, ethyl or isopropyl) or any strong dissolvent. Do not use thinner or benzene, abrasive cleaners or compressed air.
- To clean the display unit cabinet, use a cloth lightly dampened with a mild detergent.
- Avoid getting liquids inside your touchmonitor. If liquid does get inside, have a qualified service technician check it before you power it on again.
- Do not wipe the screen with a cloth or sponge that could scratch the surface.
- To clean the touchscreen, use window or glass cleaner. Put the cleaner on a clean cloth and wipe the touchscreen. Never apply the cleaner directly to the touchscreen.



Warning

This product consists of devices that may contain mercury, which must be recycled or disposed of in accordance with local, state, or federal laws. (Within this system, the backlight lamps in the monitor display contain mercury.)



Waste Electrical and Electronic Equipment(WEEE) Directive

In the European Union, this label indicates that this product should not be disposed of with household waste. It should be deposited at an appropriate facility to enable recovery and recycling.

CHAPTER

B

TECHNICAL SPECIFICATIONS

Touchmonitor Specifications

Model	1529L	
LCD Display	15.0" TFT Active Matrix Panel	
Display Size	304.1(H) x 228(V) mm	
Pixel Pitch	0.297(H) x 0.297(V) mm	
Display Mode	VGA 640 x 350 (70 Hz) VGA 720 x 400 (70 Hz) VGA 640 x 480 (60 / 72 / 75 Hz) SVGA 800 x 600 (56 / 60 / 72 / 75Hz) XGA 1024 x 768 (60 / 70 / 75Hz)	
Native	XGA 1024 x 768	
Contrast Ratio	500 : 1 (typical)	
Brightness	350 cd/m ² , AT 280 cd/m ² , IT 315 cd/m ² , IR 315 cd/m ² , SC 298 cd/m ²	
LCD	350 cd/m ² (Typical); 270 cd/m ² (Minimum)	
AccuTouch	280 cd/m ² (Typical); 203 cd/m ² (Minimum)	
IntelliTouch	315 cd/m ² (Typical); 230 cd/m ² (Minimum)	
CarrollTouch	315 cd/m ² (Typical); 230 cd/m ² (Minimum)	
Surface Capacitive	298 cd/m ² (Typical); 216 cd/m ² (Minimum)	
Acoustic Pulse Recognition	315 cd/m ² (Typical); 230 cd/m ² (Minimum)	
Response Time	Tr= 2 msec, Tf= 6 msec typical(CPT CLAA150XP01PQ) Tr= 5.7 msec, Tf= 2.3 msec typical(AU G150XG01_V1)	
Display Color	16.2 million color, 6 bit + FRC	
Viewing Angle	(L/R)= -70°/+70° (typical), (U/D) -60°/+60° (typical)	
Input Signal	VGA Analog Video	R.G.B. Analog 0.7V peak to peak
	Sync	TTL Positive or Negative, Composite Sync, Sync on green
	DVI Video	Digital TMDS Input
Signal Connector	15 Pin D-Sub, DVI-D	
Front Control	Power on / off , Menu, ▲ , ▼ , Select	
OSD	Contrast, Brightness, H/V-Position, Recall default, Color Temperature, Volume, Sharpness, Phase, Clock OSD H/V position, OSD Time, Auto Adjust, OSD Language, Input Select	
Plug & Play	DDC 2B	
Touch Panel (optional)	AccuTouch, IntelliTouch and CarrollTouch, Surface Capacitive, Acoustic Pulse Recognition	
Power	Input: AC 85-265V, 47-63Hz, or DC 12V/4A (max.)	
Operating Conditions	Temp	0°C ~ 40°C (41°F ~ 95°F)
	Humidity	20% ~ 80% (No Condensation)
		Altitude To 12,000 Feet
Dimensions (HxWxD)	354 x 301 x 285mm	
Weight (Net)	20.1lbs., monitor weight 16.2 lbs.	
Certifications	UL, C-UL, FCC-B, CE, Semko, VCCI, MPRII, C-TICK, Argentina S-Mark	

15" LCD Touchmonitor(1529L) Dimensions

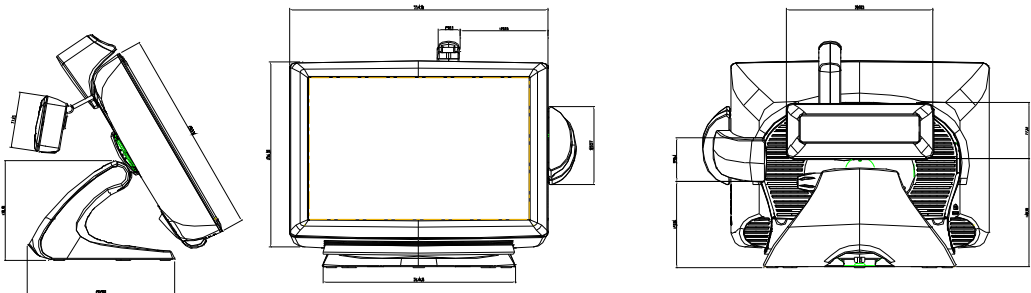

15" LCD Touchmonitor(1529L) Dimensions

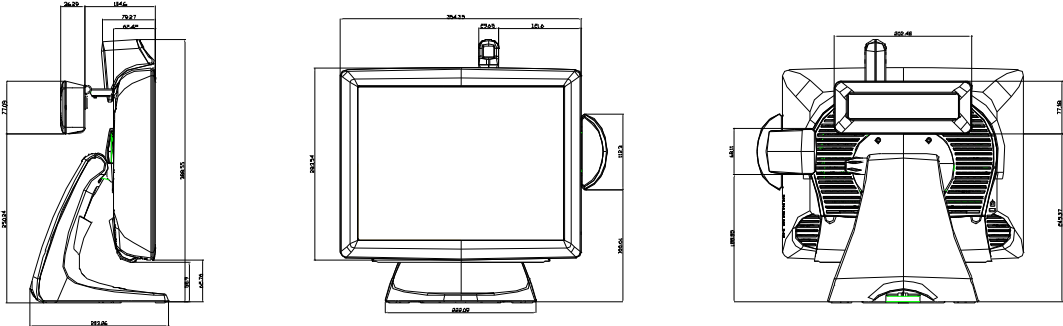

REGULATORY INFORMATION

I. Electrical Safety Information:

- A) Compliance is required with respect to the voltage, frequency, and current requirements indicated on the manufacturer's label. Connection to a different power source than those specified herein will likely result in improper operation, damage to the equipment or pose a fire hazard if the limitations are not followed.
- B) There are no operator serviceable parts inside this equipment. There are hazardous voltages generated by this equipment which constitute a safety hazard. Service should be provided only by a qualified service technician.
- C) Contact a qualified electrician or the manufacturer if there are questions about the installation prior to connecting the equipment to mains power.

II. Emissions and Immunity Information

- A) Notice to Users in the United States: This equipment has been tested and found to comply with the limits for a Class B digital device, pursuant to Part 15 of FCC Rules. These limits are designed to provide reasonable protection against harmful interference in a residential installation. This equipment generates, uses, and can radiate radio frequency energy, and if not installed and used in accordance with the instructions, may cause harmful interference to radio communications.
- B) Notice to Users in Canada: This equipment complies with the Class B limits for radio noise emissions from digital apparatus as established by the Radio Interference Regulations of Industrie Canada.
- C) Notice to Users in the European Union: Use only the provided power cords and interconnecting cabling provided with the equipment. Substitution of provided cords and cabling may compromise electrical safety or CE Mark Certification for emissions or immunity as required by the following standards: This Information Technology Equipment (ITE) is required to have a CE Mark on the manufacturer's label which means that the equipment has been tested to the following Directives and Standards: This equipment has been tested to the requirements for the CE Mark as required by EMC Directive 89/336/EEC indicated in European Standard EN 55022 Class B and the Low Voltage Directive 73/23/EEC as indicated in European Standard EN 60950.

D) General Information to all Users: This equipment generates, uses and can radiate radio frequency energy. If not installed and used according to this manual the equipment may cause interference with radio and television communications. There is, however, no guarantee that interference will not occur in any particular installation due to site-specific factors.

- 1) In order to meet emission and immunity requirements, the user must observe the following:
 - a) Use only the provided I/O cables to connect this digital device with any computer.
 - b) To ensure compliance, use only the provided manufacturer's approved line cord.
 - c) The user is cautioned that changes or modifications to the equipment not expressly approved by the party responsible for compliance could void the user's authority to operate the equipment.
- 2) If this equipment appears to cause interference with radio or television reception, or any other device:
 - a) Verify as an emission source by turning the equipment off and on.
 - b) If you determine that this equipment is causing the interference, try to correct the interference by using one or more of the following measures:
 - i) Move the digital device away from the affected receiver.
 - ii) Reposition (turn) the digital device with respect to the affected receiver.
 - iii) Reorient the affected receiver's antenna.
 - iv) Plug the digital device into a different AC outlet so the digital device and
 - v) Disconnect and remove any I/O cables that the digital device does not use. (Unterminated I/O cables are a potential source of high RF emission levels.)
 - vi) Plug the digital device into only a grounded outlet receptacle. Do not use AC adapter plugs. (Removing or cutting the line cord ground may increase RF emission levels and may also present a lethal shock hazard to the user.)

If you need additional help, consult your dealer, manufacturer, or an experienced radio or television technician.

III. Agency Certifications

The following certifications have been issued for this monitor:

- Argentina S-Mark
- Australia C-Tick
- Canada CUL
- Canada IC
- Europe CE
- Japan VCCI
- Europe Europe Semko
- United States UL
- FCC
- Sweden MPR II

Laser Notice

CAUTION: Laser radiation when open. DO NOT STARE INTO BEAM.

WARRANTY

Except as otherwise stated herein or in an order acknowledgment delivered to Buyer, Seller warrants to Buyer that the Product shall be free of defects in materials and workmanship. The warranty for the touchmonitors and components of the product is 3 (three) years.

Seller makes no warranty regarding the model life of components. Seller's suppliers may at any time and from time to time make changes in the components delivered as Products or components.

Buyer shall notify Seller in writing promptly (and in no case later than thirty (30) days after discovery) of the failure of any Product to conform to the warranty set forth above; shall describe in commercially reasonable detail in such notice the symptoms associated with such failure; and shall provide to Seller the opportunity to inspect such Products as installed, if possible. The notice must be received by Seller during the Warranty Period for such product, unless otherwise directed in writing by the Seller. Within thirty (30) days after submitting such notice, Buyer shall package the allegedly defective Product in its original shipping carton(s) or a functional equivalent and shall ship to Seller at Buyer's expense and risk.

Within a reasonable time after receipt of the allegedly defective Product and verification by Seller that the Product fails to meet the warranty set forth above, Seller shall correct such failure by, at Seller's options, either (i) modifying or repairing the Product or (ii) replacing the Product. Such modification, repair, or replacement and the return shipment of the Product with minimum insurance to Buyer shall be at Seller's expense. Buyer shall bear the risk of loss or damage in transit, and may insure the Product. Buyer shall reimburse Seller for transportation cost incurred for Product returned but not found by Seller to be defective. Modification or repair, of Products may, at Seller's option, take place either at Seller's facilities or at Buyer's premises. If Seller is unable to modify, repair, or replace a Product to conform to the warranty set forth above, then Seller shall, at Seller's option, either refund to Buyer or credit to Buyer's account the purchase price of the Product less depreciation calculated on a straight-line basis over Seller's stated Warranty Period.

THESE REMEDIES SHALL BE THE BUYER'S EXCLUSIVE REMEDIES FOR BREACH OF WARRANTY. EXCEPT FOR THE EXPRESS WARRANTY SET FORTH ABOVE, SELLER GRANTS NO OTHER WARRANTIES, EXPRESS OR IMPLIED BY STATUTE OR OTHERWISE, REGARDING THE PRODUCTS, THEIR FITNESS FOR ANY PURPOSE, THEIR QUALITY, THEIR MERCHANTABILITY, THEIR NON-INFRINGEMENT, OR OTHERWISE. NO EMPLOYEE OF SELLER OR ANY OTHER PARTY IS AUTHORIZED TO MAKE ANY WARRANTY FOR THE GOODS OTHER THAN THE WARRANTY SET FORTH HEREIN. SELLER'S LIABILITY UNDER THE WARRANTY SHALL BE LIMITED TO A REFUND OF THE PURCHASE PRICE OF THE PRODUCT. IN NO EVENT SHALL SELLER BE LIABLE FOR THE COST OF PROCUREMENT OR INSTALLATION OF SUBSTITUTE GOODS BY BUYER OR FOR ANY SPECIAL, CONSEQUENTIAL, INDIRECT, OR INCIDENTAL DAMAGES.

Buyer assumes the risk and agrees to indemnify Seller against and hold Seller harmless from all liability relating to (i) assessing the suitability for Buyer's intended use of the Products and of any system design or drawing and (ii) determining the compliance of Buyer's use of the Products with applicable laws, regulations, codes, and standards. Buyer retains and accepts full responsibility for all warranty and other claims relating to or arising from Buyer's products, which include or incorporate Products or components manufactured or supplied by Seller. Buyer is solely responsible for any and all representations and warranties regarding the Products made or authorized by Buyer. Buyer will indemnify Seller and hold Seller harmless from any liability, claims, loss, cost, or expenses (including reasonable attorney's fees) attributable to Buyer's products or representations or warranties concerning same.

Check out Elo's Website!

www.elotouch.com

Get the latest...

• **Product information**

• **Specifications**

• **News on upcoming events**

• **Press release**

• **Software drivers**

• **Touchmonitor Newsletter**

Getting in Touch with Elo

To find out more about Elo's extensive range of touch solutions, visit our Website at www.elotouch.com or simply call the office nearest you:

North America

Elo TouchSystems
301 Constitution Drive,
Menlo Park, CA 94025
USA

(800) ELO-TOUCH

(800-557-1458)

Tel 650-361-4800

Fax 650-361-4722

customerservice@elotouch.com

Germany

Tyco Electronics Raychem GmbH
(Elo TouchSystems Division)
Finsinger Feld 1
D-85521 Ottobrunn
Germany

Tel +49(0)(89)60822-0

Fax +49(0)(89)60822-180

elosales@elotouch.com

Belgium

Tyco Electronics Raychem GmbH
(Elo TouchSystems Division)
Diestsesteenweg 692
B-3010 Kessel-Lo
Belgium

Tel +32(0)(16)35-2100

Fax +32(0)(16)35-2101

elosales@elotouch.com

Asian-Pacific

Sun Homada Bldg. 2F
1-19-20 Shin-Yokohama
Kanagawa 222-0033
Japan

Tel +81(45)478-2161

Fax +81(45)478-2180

www.tps.co.jp

© 2009 Tyco Electronics. Printed in USA

